



DW ECO 2.0

Double wall insulated stainless steel chimney system

www.jeremias.de/int



Page 2

Jeremias Group
STRONG, OPEN,
INTERNATIONAL GROUP

Page 3

Jeremias Group
SERVICE, QUALITY
AND INNOVATION

Page 4

Jeremias Group
QUALITY AND RESOURCES /
TECHNICAL SUPPORT

Page 5

DW ECO 2.0
PRODUCT DESCRIPTION

Page 6

DW ECO 2.0
SYSTEM SPECIFICATION
AND CE DESIGNATIONS

Page 7

DW ECO 2.0
SYSTEM APPLICATIONS

Page 8-19

DW ECO 2.0
PRODUCTS

Page 20

DW ECO 2.0
OFFSETS & ANGLES

Page 21

DW ECO 2.0
WEIGHTS AND
INSTALLATION HEIGHT

Page 22-23

DW ECO 2.0
INSTALLATION

STRONG, OPEN, INTERNATIONAL GROUP

The **Jeremias Group** has more than

40 years experience

in the flue and chimney production.

The headquarters are situated in Germany. The Jeremias Group has expanded its activities steadily in Europe being now the single stainless steel chimney manufacturer with

8 Production locations in 6 different countries.

Besides production and own sales offices, Jeremias has strong cooperation partnerships with chimney specialist companies all over Europe.

Jeremias is one of the world's leading manufacturers of flue and chimney systems for the exhaust of gases and ventilation, covering all kind of domestic, commercial and industrial applications. Jeremias product range include

100 different CE certified systems

covering commercial and domestic applications complemented by freestanding Industrial steel chimneys up to 4 meter diameter.

Jeremias offers its clients a wide range of high quality products, technical support for Projects, chimney sizing software, European CE Certification in a modern and dynamic company able to satisfy a wide variety of the flue market requirements needed in the market.





SERVICE

- > Flexible production line
- > Total flexibility for special parts (customization)
- > Design of project drawings
- > Chimney sizing
- > Test-capable chimney static calculations
- > Biggest product range in the market
- > Development for market-focused system solutions
- > Country specific certifications and installation advice

QUALITY

- > CNC Laser technology
- > CNC stamping technology
- > Modern 3D CAD software
- > Special stainless steel alloys
- > 3D laser cutting

INNOVATION

- > System development with Boiler, CHP and Stove manufacturers
- > Own specific machine development
- > Own Test laboratory for acoustic R&I silencer development



QUALITY AND RESOURCES

Manufactured in accordance with the EN 1856-1 (performance requirements for metal chimney systems) and under Quality Assurance EN ISO 9001:2000

Jeremias Products have achieved designations for all normal applications, in domestic, commercial and industrial projects.

Besides this compulsory CE Certification, Jeremias has also special certifications and listings needed in specific countries under i.e.; BS, Hetas, Swiss, Russian or US standards.

For further information, Jeremias can supply technical guidance on various standards including the latest version of the European Standard 1856-1:2010. Please contact our certification department.

TECHNICAL SUPPORT

- > Chimney sizing
- > Fire rating advice
- > Mechanically controlled ventilation calculation
- > Design and system recommendation
- > Structural design and test-capable chimney static calculations
- > Supply and install service (own installers, or via accredited specialists)
- > After sales service
- > Product Warranty



SYSTEM APPLICATIONS



CHIMNEY SYSTEMS

- > Heating and hot water
- > Chimney relining systems
- > Concentric balance flue systems
- > Shared collective chimney systems CLV
- > Plastic relining systems
- > Fan dilution / fan assisted systems
- > Freestanding Chimneys
- > Mast Supported Chimneys
- > Windshield Chimneys



EXHAUST SYSTEMS

- > Generator / turbine exhausts
- > Cogeneration / CHP
- > Incinerator exhausts
- > Industrial process exhausts
- > Engine exhausts
- > Dry oven exhaust
- > Kitchen exhausts
- > Micro-cogeneration



SMOKE EXTRACT SYSTEMS

- > Fire rated smoke ducts to BS 476 pt 20 (4 hours)
- > Fire rated ventilation ducts to UNE-EN 13501
- > Laundry / refuse chutes



VENTILATION

- > Free standing ventilation towers
- > Fire rated ventilation ducts
- > Mechanically controlled ventilation systems

DW ECO 2.0

PRODUCT DESCRIPTION

DW ECO 2.0 is a multi fuel, twin wall insulated stainless steel flue system suitable for all applications in negative and positive pressure, including condensing (joint seals).

Designed for use with all gas, oil, pellet, wood, coal domestic, commercial or industrial appliances.

MAIN FEATURES:

- > Simple open ended push-fit jointing system, secured by locking band.
- > 70 mm wide recessed locking band, aesthetically pleasing look.
- > 60 mm plugged in joint + wider locking band = better holding in horizontal runs.
- > Homogenous 25 mm high quality rigid rock wool insulation with 120 kg/cubic meter guaranteed density.
- > Continuous insulation: No thermal bridge between inner and outer steel case.
- > Low outer case temperature.
- > Operating temperature of 600° C - Soot fire tested at 1000° C.
- > Free expansion of the inner flue liner, assuring the integrity of the flue after a soot fire.
- > 4 hour fire rated to BS 476 part 20.
- > Jointing system with capillary break prevents moisture being drawn through the joint.
- > Positive pressure till 200 pa with the use of joint seals in the socket of the inner liner specially designed for modern condensing appliances.
- > 3 meters freestanding above last support.
- > Lateral support every 4 metres.
- > Load bearing support every 16 metres.
- > Full range of accessories

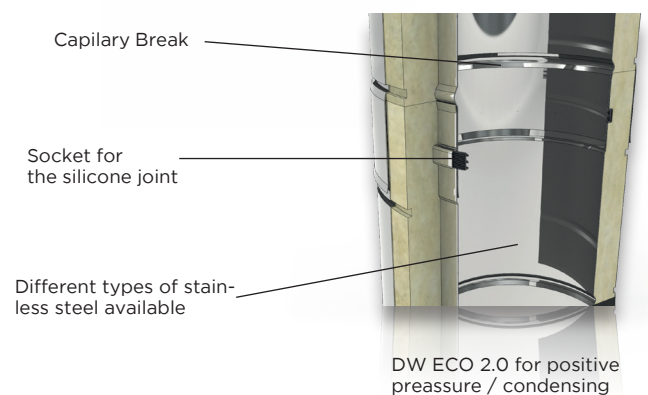

DW ECO 2.0 SYSTEM SPECIFICATION AND CE DESIGNATIONS:

DW ECO 2.0 is CE Certified to EN 1856-1 TÜV 0036 CPD 9174 030 and TÜV 0036 CPD 9174 044. For full information and certificates please contact your Jeremias team.

The **DW ECO 2.0** has been designed to cover all kind of applications. Therefore the system has been tested in different scenarios to proof different combinations of temperature, pressure and corrosion resistance.

Manufactured under a Quality Management scheme approved to EN ISO 9001: 2008

Hetas listed for use on solid fuel applications 4 hour fire rating to BS476 part 20

Certified for corrosion resistance on gas, oil and solid fuel by TÜV.

DW ECO 2.0 is a multi fuel, twin wall insulated stainless steel flue system suitable for all applications in negative and positive pressure, including condensing (joint seals). Designed for use with all gas, oil, pellet, wood, coal domestic, commercial or industrial appliances. Maximum constant working temperature 600° C and short firing up to 700° C with thermal shock testing up to 1000° C.

DW ECO 2.0 is HETAS listed for use with all pellet, wood, and multi fuel domestic appliances (stoves and fire-places) maximum constant working temperature 450° C and short firing up to 550° C with thermal shock testing up to 1000° C.



EN 1856-1 T600 N1 D V3-L50040 G70



EN 1856-1 T450 N1 D V3-L50040 G60

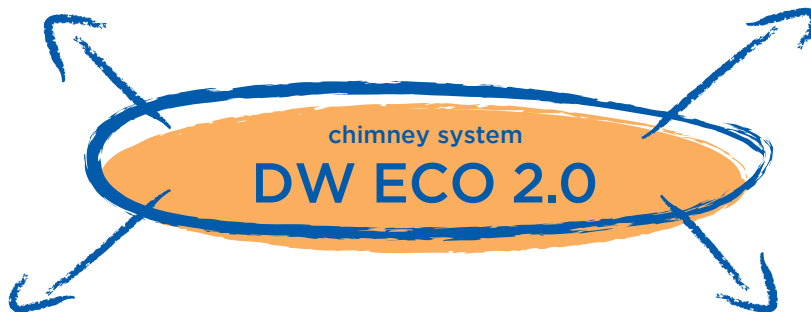

DW ECO 2.0 is designed for use with all gas, oil, domestic, commercial or industrial appliances with natural draught in wet conditions with a maximum constant working temperature 400° C and short firing up to 450° C.

All the components of the **DW ECO 2.0** are water resistant and able to operate with the new generation of condensing gas, oil and solid fuel appliances by adding a joint seal in the inner liner of each component.

Designed for a continuous operating temperature up to 200° C, short firing up to 250° C and positive pressure up to 200 pa at the appliance outlet.



EN 1856-1 T400 N1 W V2-L50040 O30



EN 1856-1 T200 P1 W V2-L50040 O00

The system **DW ECO 2.0** can be supplied with alternative alloys in the inner liner.

Please contact your Jeremias team for more information.

FLUE SIZE ADVICE

Jeremias provides **technical advice** for system application and size calculation. All the flue size calculations done by our technicians are in accordance with the requirements defined at the EN 13384-1 (single appliances) and EN 13384-2 (multi appliances) standards.

Jeremias provides the **necessary reports** for these calculations. Please take into account the flue height terminations depends on national, regional or even local authorities, therefore we recommend you to contact Jeremias at the specific country.



LENGTHS

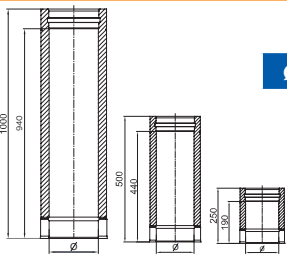

- Ø
- 130
- 150
- 180
- 200
- 250
- 300
- 350
- 400
- 450
- 500
- 550
- 600

- DWECO - 13
- DWECO - 14
- DWECO - 15

- Length**
- 1000 mm
 - 500 mm
 - 250 mm

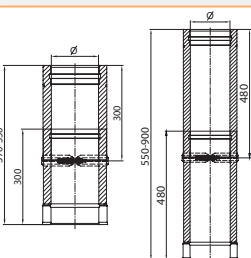

- Ø
- 130
- 150
- 180
- 200
- 250
- 300
- 350
- 400
- 450
- 500
- 550
- 600

- DWECO - 544
- DWECO - 545

- Adjustable length**
- 370 - 550 mm
 - 550 - 900 mm

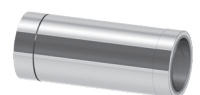

ELBOWS & TEES

The double wall insulated chimney system DW ECO 2.0 can be manufactured with different kind of stainless steel alloys, different liner thicknesses and different insulation thicknesses. Please contact your Jeremias partner for detailed information of codes and prices.

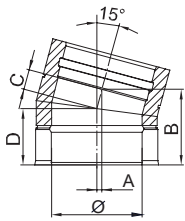

Elbow 15° / DWECO - 16

Ø	130	150	180	200	250	300	350	400	450	500	550	600
A	8	8	9	9	10	11	11	12	13	14	15	16
B	119	121	125	128	134	141	147	154	160	167	173	180
C	30	31	33	34	38	41	44	48	51	54	58	61
D	90	91	93	94	98	101	104	108	111	114	118	121

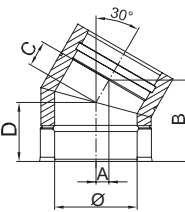

Elbow 30° / DWECO - 17

Ø	130	150	180	200	250	300	350	400	450	500	550	600
A	21	22	24	26	29	32	36	39	42	46	49	53
B	139	144	151	156	169	181	194	206	219	231	244	256
C	42	45	49	51	58	65	72	78	85	92	98	105
D	102	105	109	111	118	125	132	138	145	152	158	165

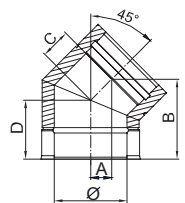

Elbow 45° / DWECO - 18

Ø	130	150	180	200	250	300	350	400	450	500	550	600
A	39	42	46	49	57	64	71	79	86	93	101	108
B	154	161	172	179	197	214	232	250	268	285	303	321
C	55	59	66	70	80	90	101	111	122	132	142	153
D	115	119	126	130	140	150	161	171	182	192	202	213

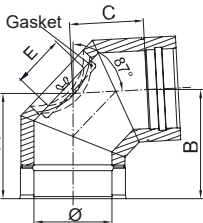

Elbow 87° / DWECO - 64

Ø	130	150	180	200	250	300	350	400	450	500	550	600
A	191	200	215	224	248	272	295	319	343	367	390	414
B	198	208	223	233	258	283	308	333	358	383	408	433
C	131	140	155	164	188	212	235	259	283	307	330	354
E	114	118	124	128	138	148	158	168	178	188	198	208

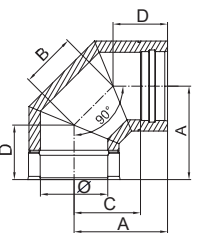

Elbow 90° / DWECO - 60

Ø	130	150	180	200	250	300	350	400	450	500	550	600
A	196	206	221	231	256	281	306	331	356	381	406	431
B	115	123	135	144	164	185	206	226	247	268	289	309
C	136	146	161	171	196	221	246	271	296	321	346	371
D	115	119	126	130	140	150	161	171	182	192	202	213

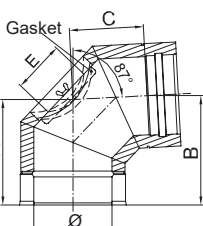

Elbow 87° with inspection / DWECO - 67

Ø	130	150	180	200	250	300	350	400	450	500	550	600
A	191	200	215	224	248	272	295	319	343	367	390	414
B	198	208	223	233	258	283	308	333	358	383	408	433
C	131	140	155	164	188	212	235	259	283	307	330	354
E	114	118	124	128	138	148	158	168	178	188	198	208



ELBOWS & TEES

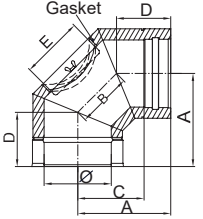

Elbow 90° with inspection / DWECO - 19

Ø	130	150	180	200	250	300	350	400	450	500	550	600
A	196	206	221	231	256	281	306	331	356	381	406	431
B	115	123	135	144	164	185	206	226	247	268	289	309
C	136	146	161	171	196	221	246	271	296	321	346	371
D	115	119	126	130	140	150	161	171	182	192	202	213
E	100	130	130	130	180	180	200	200	200	200	250	250

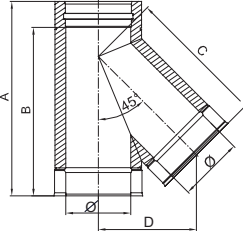
Tee 135° / 45° / DWECO - 12

Ø	130	150	180	200	250	300	350	400	450	500	550	600
A	416	446	486	516	586	656	726	806	876	946	1016	1086
B	356	386	426	456	526	596	666	746	816	886	956	1026
C	295	319	356	380	440	500	561	621	682	742	802	863
D	209	226	251	269	311	354	397	439	482	525	567	610

Tee 87° / DWECO - 1055

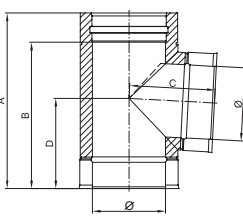
Ø	130	150	180	200	250	300	350	400	450	500	550	600
A	356	376	406	426	476	526	576	626	676	726	776	826
B	296	316	346	366	416	466	516	566	616	666	716	766
C	183	193	209	220	246	272	299	325	351	378	404	430
D	183	193	209	220	246	272	299	325	351	377	404	430

Tee 90° / DWECO - 11

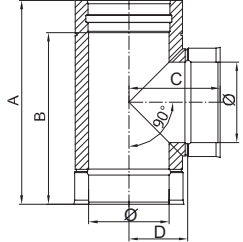
Ø	130	150	180	200	250	300	350	400	450	500	550	600
A	356	376	406	426	476	526	576	626	676	726	776	826
B	296	316	346	366	416	466	516	566	616	666	716	766
C	178	188	203	213	238	263	288	313	338	363	388	413
D	118	128	143	153	178	203	228	253	278	303	328	353



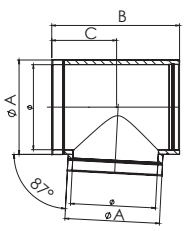

Header-T / cascade / DWECO - 1207

Ø	130	150	180	200	250	300	350	400	450	500	550	600
A	180	200	230	250	300	350	400	450	500	550	600	650
B	356	376	406	426	476	526	576	626	676	726	776	826
C	183	193	209	220	246	272	299	325	351	377	404	430

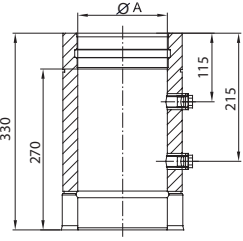

INSPECTION & CLEANING



Length with measurement connector / DWECO - 543

Ø	130	150	180	200	250	300	350	400	450	500	550	600
A	180	200	230	250	300	350	400	450	500	550	600	650

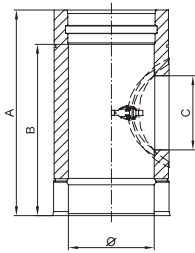
Inspection length with door 40 pa (N1) / DWECO - 68

Ø	130	150	180	200	250	300	350	400	450	500	550	600
A	330	360	360	360	360	400	500	500	500	500	500	500
B	270	300	300	300	300	340	440	440	440	440	440	440
C	100	130	130	130	130	150	200	200	200	200	200	200

Inspection length with door 200 pa (P1) / DWECO - 549

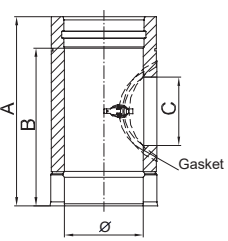
Ø	130	150	180	200	250	300	350	400	450	500	550	600
A	330	360	360	360	360	400	500	500	500	500	500	500
B	270	300	300	300	300	340	440	440	440	440	440	440
C	100	130	130	130	130	150	200	200	200	200	200	200

Tee-cap / DWECO - 43

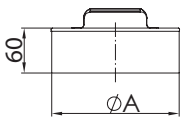
Ø	130	150	180	200	250	300	350	400	450	500	550	600
A	180	200	230	250	300	350	400	450	500	550	600	650

Height
60 mm

Tee-cap with drain / DWECO - 44

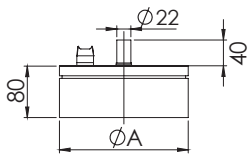
Ø	130	150	180	200	250	300	350	400	450	500	550	600
A	180	200	230	250	300	350	400	450	500	550	600	650

Height
80 mm



Jeremias has developed multiple market specific components, please contact your local Jeremias partner for advise on market specific solutions.

TERMINALS

Top Stub Terminal / DWECO - 32

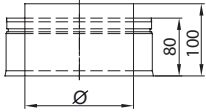

Ø	130	150	180	200	250	300	350	400	450	500	550	600
---	-----	-----	-----	-----	-----	-----	-----	-----	-----	-----	-----	-----



Rain cap Terminal / DWECO - 526

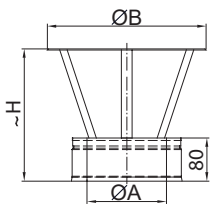

Ø	130	150	180	200	250	300	350	400	450	500	550	600
A	127	148	177	197	247	297	347	397	447	497	547	597
B	260	330	360	400	500	600	650	700	750	800	850	900
H	270	270	290	300	350	395	395	460	460	560	560	660



Rain cap + Wind Protection / DWECO - 527

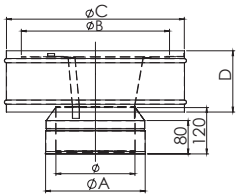

Ø	130	150	180	200	250	300	350	400	450	500	550	600
A	180	200	230	250	300	350	400	450	-	-	-	-
B	250	300	350	400	500	600	700	800	-	-	-	-
C	295	340	405	450	560	675	785	895	-	-	-	-
D	105	105	155	155	155	230	230	230	-	-	-	-

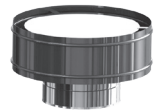

CONNECTIONS



Boiler adapter (male) / DWECO - 37M

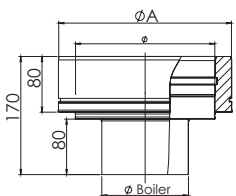

Ø	130	150	180	200	250	300	350	400	450	500	550	600
A	180	200	230	250	300	350	400	450	500	550	600	650



Boiler adapter (female) / DWECO - 37H

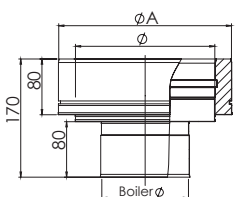

Ø	130	150	180	200	250	300	350	400	450	500	550	600
A	180	200	230	250	300	350	400	450	500	550	600	650

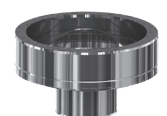

The double wall insulated chimney system DW ECO 2.0 can be manufactured with different kind of stainless steel alloys, different liner thicknesses and different insulation thicknesses. Please contact your Jeremias partner for detailed information of codes and prices.

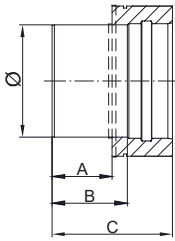

Single wall - double wall connector / DWECO - 37

Ø	130	150	180	200	250	300	350	400	450	500	550	600
A	80	80	80	80	80	80	80	80	80	80	80	80
B	100	100	100	100	100	100	100	100	100	100	100	100
C	160	160	160	160	160	160	160	160	160	160	160	160

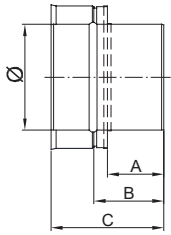
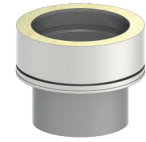

Double wall - single wall connector / DWECO - 37A

Ø	130	150	180	200	250	300	350	400	450	500	550	600
A	80	80	80	80	80	80	80	80	80	80	80	80
B	100	100	100	100	100	100	100	100	100	100	100	100
C	160	160	160	160	160	160	160	160	160	160	160	160

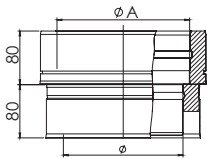
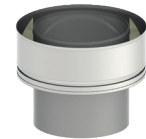

Increaser / DWECO - 983

Ø	130	150	180	200	250	300	350	400	450	500	550	600
A	150	180	200	250	300	350	400	450	500	550	600	-

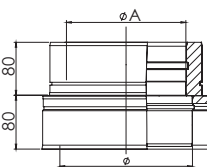
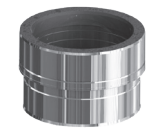

Decreaser / DWECO - 982

Ø	130	150	180	200	250	300	350	400	450	500	550	600
A	100	130	150	180	200	250	300	350	400	450	500	550

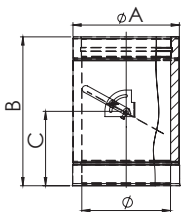

Draft damper / DWECO - 531

Ø	130	150	180	200	250	300	350	400	450	500	550	600
A	180	200	230	250	300	350	400	450	500	550	600	650
B	300	320	350	370	420	470	520	570	620	670	720	770
C	150	160	175	185	210	235	260	285	310	335	360	385

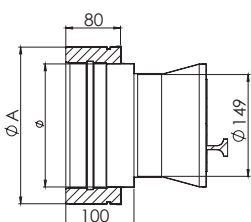

Draft stabiliser / DWECO - 970

Ø	130	150	180	200	250	300	350	400	450	500	550	600
A	180	200	230	250	300	350	400	450	500	550	600	650

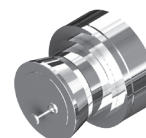

FIXING & BRACKETS

Jeremias has developed multiple market specific components, please contact your local Jeremias partner for advise on market specific solutions.

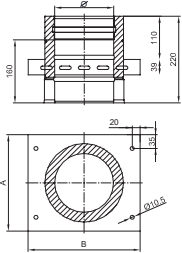

Base plate for intermediate support / DWECO - 07

Ø	130	150	180	200	250	300	350	400	450	500	550	600
A	225	245	275	295	345	395	445	495	545	595	645	695
B	305	325	355	375	425	475	525	575	625	675	725	775

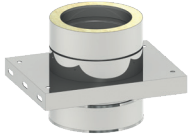
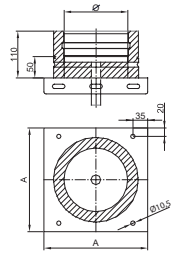
Base plate with condensate outlet at bottom / DWECO - 05

Ø	130	150	180	200	250	300	350	400	450	500	550	600
A	225	245	275	295	345	395	445	495	545	595	645	695

Base plate with side drain / DWECO - 66

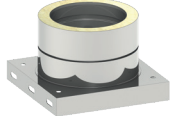
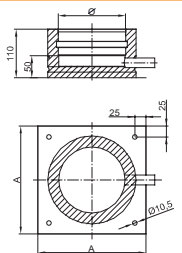
Ø	130	150	180	200	250	300	350	400	450	500	550	600
A	225	245	275	295	345	395	445	495	545	595	645	695

Adjustable base support 60 - 520 mm / DWECO - 03

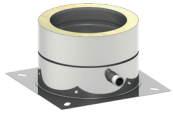
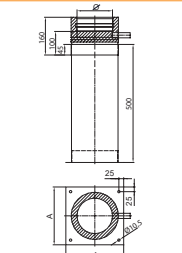
Ø	130	150	180	200	250	300	350	400	450	500	550	600
A	225	245	275	295	345	395	445	495	545	595	645	695

Base plate for chimney raise / DWECO - 08

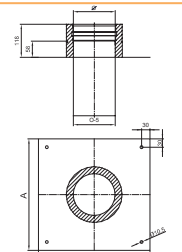
Ø	130	150	180	200	250	300	350	400	450	500	550	600
A	400	400	400	400	400	450	500	550	600	650	700	750

Base plate with lateral condensate outlet / DWECO - 06

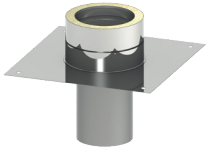
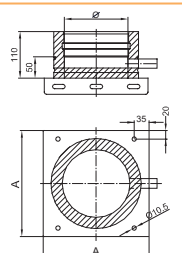
Ø	130	150	180	200	250	300	350	400	450	500	550	600
A	225	245	275	295	345	395	445	495	545	595	645	695

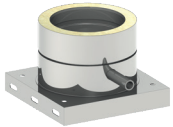

Calculating wall brace and crossbars

Wall support and cross rail 350 mm / DW391

internal pipe Ø	130	150	180	200	-	-	-	-	-	-
x in mm	155	135	105	85	-	-	-	-	-	-



Wall support and cross rail 500 mm / DW392

internal pipe Ø	130	150	180	200	250	300	350	-	-	-
x in mm	305	285	255	235	185	135	85	-	-	-



Wall support and cross rail 750 mm / DW393

internal pipe Ø	130	150	180	200	250	300	350	400	450	500
x in mm	555	535	505	485	435	385	335	285	235	185



Wall support and cross rail 1030 mm / DW407

internal pipe Ø	130	150	180	200	250	300	350	400	450	500
x in mm	835	815	785	765	715	665	615	565	515	465

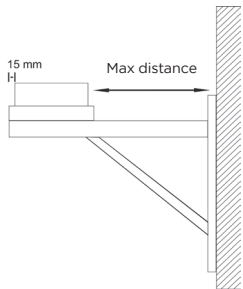

x = maximum distance from wall in mm

Adjustable wall bracket 50 - 70 mm / DWECO - 690

Ø	130	150	180	200	250	300	350	400	450	500
A	180	200	230	250	300	350	400	450	500	550
B	50-75	50-75	50-75	50-75	50-75	50-75	50-75	50-75	50-75	50-75
C	70	85	95	115	140	150	185	220	280	292

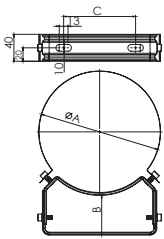

Adjustable wall bracket 50 - 150 mm / DWECO - 22

Ø	130	150	180	200	250	300	350	400	450	500	550	600
A	180	200	230	250	300	350	400	450	500	550	600	650
B	164	195	210	225	255	295	328	417	417	480	480	480
C	130	130	130	130	370	400	400	480	480	545	545	545

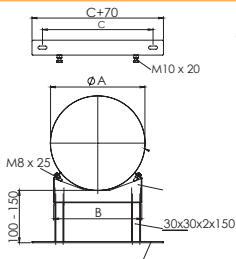
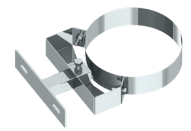

Adjustable wall bracket 150 - 250 mm / DWECO - 23

Ø	130	150	180	200	250	300	350	400	450	500	550	600
A	180	200	230	250	300	350	400	450	500	550	600	650
B	164	195	210	225	255	295	328	417	417	480	480	480
C	130	130	130	130	370	400	400	480	480	545	545	545

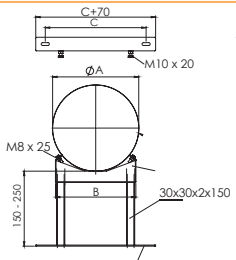
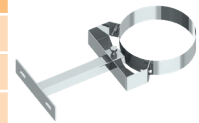

Adjustable wall bracket 250 - 360 mm / DWECO - 24

Ø	130	150	180	200	250	300	350	400	450	500	550	600
A	180	200	230	250	300	350	400	450	500	550	600	650
B	164	195	210	225	255	295	328	417	417	480	480	480
C	170	170	170	170	370	400	400	480	480	545	545	545

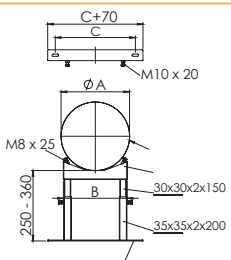

FIXINGS & BRACKETS

Guy wire bracket / DWECO - 42



Ø	130	150	180	200	250	300	350	400	450	500	550	600
A	180	200	230	250	300	350	400	450	500	550	600	650



Wall support bracket / DWECO - 858

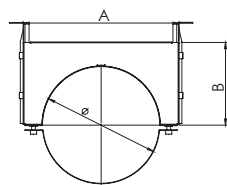

Ø	180	200	230	250	300	350	400	450	500	550	600	650
A	260	280	310	330	380	430	480	530	580	630	680	730
B	140	150	165	175	200	225	250	275	300	325	350	375

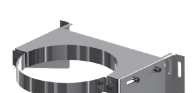

Split ring / DWECO - 1063

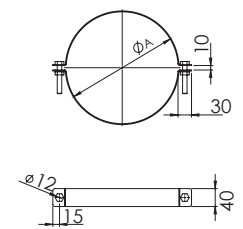

Ø	130	150	180	200	250	300	350	400	450	500	550	600
A	180	200	230	250	300	350	400	450	500	550	600	650



Swivel ring (ceiling hanger) / DWECO - 1062

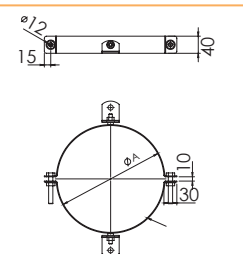

Ø	130	150	180	200	250	300	350	400	450	500	550	600
A	180	200	230	250	300	350	400	450	500	550	600	650



Rigid guy wire bracket / DWECO - 191

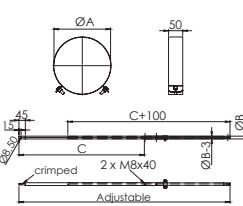

Ø	130	150	180	200	250	300	350	400	450	500	550	600
A	180	200	230	250	300	350	400	450	500	550	600	650
B	20	20	20	20	20	20	20	30	30	30	30	30
C	1000 - 2000											



Steel Flat Flashing + Storm Collar / DWECO - 52

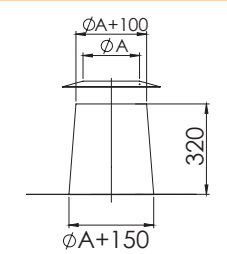

Ø	130	150	180	200	250	300	350	400	450	500	550	600
A	130	150	180	200	250	300	350	400	450	500	550	600
B	580	600	630	650	700	750	800	850	900	950	1000	1050



FLASHINGS

The double wall insulated chimney system DW ECO 2.0 can be manufactured with different kind of stainless steel alloys, different liner thicknesses and different insulation thicknesses. Please contact your Jeremias partner for detailed information of codes and prices.

Flashing 5° - 15° lead base + Storm Collar / DWECO - 53

Ø	130	150	180	200	250	300	350	400	450	500	550	600
A	180	200	230	250	300	350	400	450	-	-	-	-
B	230	250	280	300	350	400	450	500	-	-	-	-
C	200	200	200	200	200	200	200	200	-	-	-	-
D	320	320	320	320	320	320	320	320	-	-	-	-

Flashing 16° - 25° lead base + Storm Collar / DWECO - 59

Ø	130	150	180	200	250	300	350	400	450	500	550	600
A	180	200	230	250	300	350	400	450	-	-	-	-
B	230	250	280	300	350	400	450	500	-	-	-	-
C	200	200	200	200	200	200	200	200	-	-	-	-
D	320	320	320	320	320	320	320	320	-	-	-	-

Flashing 26° - 35° lead base + Storm Collar / DWECO - 38

Ø	130	150	180	200	250	300	350	400	450	500	550	600
A	180	200	230	250	300	350	400	450	-	-	-	-
B	230	250	280	300	350	400	450	500	-	-	-	-
C	200	200	200	200	200	200	200	200	-	-	-	-
D	320	320	320	320	320	420	420	420	-	-	-	-

Flashing 36° - 45° lead base + Storm Collar / DWECO - 54

Ø	130	150	180	200	250	300	350	400	450	500	550	600
A	180	200	230	250	300	350	400	450	-	-	-	-
B	230	250	280	300	350	400	450	500	-	-	-	-
C	200	200	200	200	200	200	200	200	-	-	-	-
D	320	320	320	320	320	420	420	420	-	-	-	-

Storm Collar / embellisher / DWECO - 31

Ø	130	150	180	200	250	300	350	400	450	500	550	600
A	180	200	230	250	300	350	400	450	500	550	600	650

Storm Collar Plus Design / DWECO - 307

Ø	130	150	180	200	250	300	350	400	450	500	550	600
A	180	200	230	250	300	350	400	450	500	550	600	650

FLASHINGS

Jeremias has developed multiple market specific components, please contact your local Jeremias partner for advise on market specific solutions.

Roof bracing bracket / Adjustable joist support / DW55

Ø	130	150	180	200	250	300	350	400	450	500	550	600
A	180	200	230	250	300	350	400	450	500	550	600	650

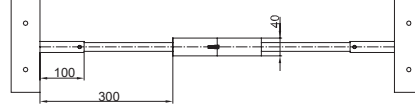
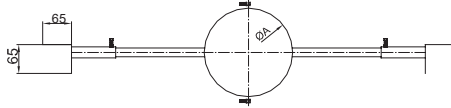

Ceiling support / DWECO - 829

Ø	150	180	200	230	250	300	350	400	-	-	-	-
A	158	188	208	238	258	-	-	-	-	-	-	-

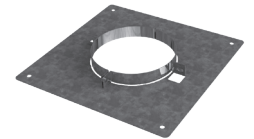
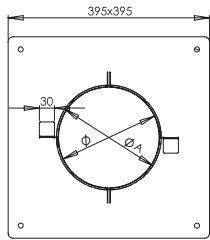

Split firestop Spacer (0° - 30°) square / DWECO - 99V

Ø	130	150	180	200	250	300	350	400	450	500	550	600
A	475	495	525	545	595	645	695	745	-	-	-	-
B	183	203	233	253	303	353	403	453	-	-	-	-
C	270	280	300	310	340	370	400	430	-	-	-	-

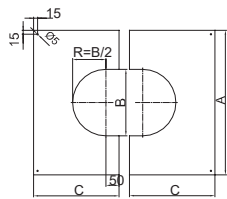

Split firestop Spacer (31° - 45°) square / DWECO - 98V

Ø	130	150	180	200	250	300	350	400	450	500	550	600
A	475	495	525	545	595	645	695	745	-	-	-	-
B	183	203	233	253	303	353	403	453	-	-	-	-
C	290	310	330	340	380	410	450	480	-	-	-	-
D	107	119	136	148	177	206	235	265	-	-	-	-

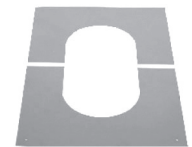
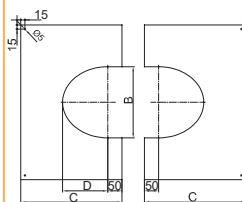

Ventilated Split firestop Spacer 0° square / DWECO - 74HL

Ø	180	200	230	250	-	-	-	-	-	-	-	-
A	475	495	525	545	-	-	-	-	-	-	-	-
B	183	203	233	253	-	-	-	-	-	-	-	-

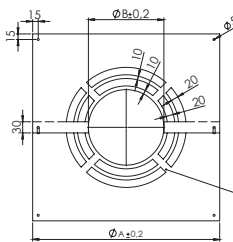

Ventilated firestop Spacer 0° square / DWECO - 70HL

Ø	180	200	230	250	-	-	-	-	-	-	-	-
A	475	495	525	545	-	-	-	-	-	-	-	-
B	183	203	233	253	-	-	-	-	-	-	-	-
D	107	119	136	148	-	-	-	-	-	-	-	-

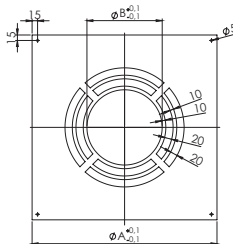



Joint seal - 200 pa / ALBI26

Ø	130	150	180	200	250	300	350	400	450	500	550	600
---	-----	-----	-----	-----	-----	-----	-----	-----	-----	-----	-----	-----

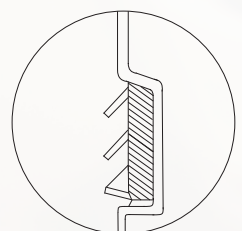
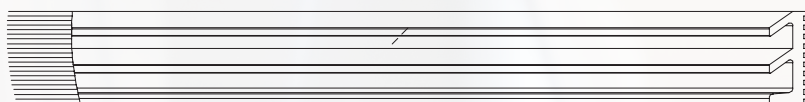
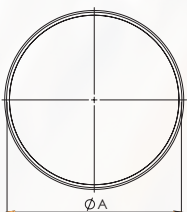

OFFSETS & ANGLES

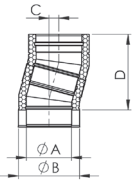

Offset DWECO 15°					
	A	B	C	D	
130	130	180	32	243	
150	150	200	33	248	
180	180	230	34	256	
200	200	250	34	261	
250	250	300	36	274	
300	300	350	38	287	
350	350	400	40	300	
400	400	450	41	313	
450	450	500	43	326	
500	500	550	45	339	
550	550	600	46	352	
600	600	650	48	365	

Offset DWECO 30°					
	A	B	C	D	
130	130	180	74	277	
150	150	200	77	287	
180	180	230	81	302	
200	200	250	84	312	
250	250	300	90	337	
300	300	350	97	362	
350	350	400	104	387	
400	400	450	110	412	
450	450	500	117	437	
500	500	550	124	462	
550	550	600	130	487	
600	600	650	137	512	

Offset DWECO 45°					
	A	B	C	D	
130	130	180	123	298	
150	150	200	129	312	
180	180	230	138	333	
200	200	250	144	348	
250	250	300	159	383	
300	300	350	173	418	
350	350	400	188	454	
400	400	450	203	489	
450	450	500	217	524	
500	500	550	232	560	
550	550	600	246	595	
600	600	650	261	630	

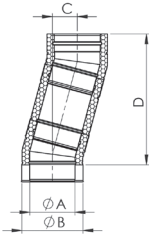

Offset DWECO 15° + Length 250					
	A	B	C	D	
130	130	180	81	427	
150	150	200	82	432	
180	180	230	83	440	
200	200	250	84	445	
250	250	300	85	458	
300	300	350	87	471	
350	350	400	89	484	
400	400	450	90	497	
450	450	500	92	510	
500	500	550	94	523	
550	550	600	96	535	
600	600	650	97	548	

Offset DWECO 30° + Length 250					
	A	B	C	D	
130	130	180	169	441	
150	150	200	172	451	
180	180	230	176	466	
200	200	250	179	476	
250	250	300	185	501	
300	300	350	192	526	
350	350	400	199	551	
400	400	450	205	576	
450	450	500	212	601	
500	500	550	219	626	
550	550	600	225	651	
600	600	650	232	676	

Offset DWECO 45° + Length 250					
	A	B	C	D	
130	130	180	258	432	
150	150	200	264	447	
180	180	230	272	468	
200	200	250	278	482	
250	250	300	293	517	
300	300	350	308	553	
350	350	400	322	588	
400	400	450	337	623	
450	450	500	352	659	
500	500	550	366	694	
550	550	600	381	729	
600	600	650	395	765	

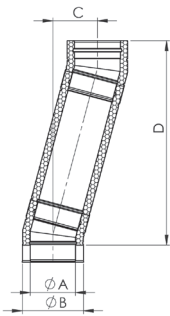

Offset DWECO 15° + Length 500					
	A	B	C	D	
130	130	180	146	668	
150	150	200	147	673	
180	180	230	148	681	
200	200	250	148	686	
250	250	300	150	699	
300	300	350	152	712	
350	350	400	153	725	
400	400	450	155	738	
450	450	500	157	751	
500	500	550	159	764	
550	550	600	160	777	
600	600	650	162	790	

Offset DWECO 30° + Length 500					
	A	B	C	D	
130	130	180	294	658	
150	150	200	297	668	
180	180	230	301	683	
200	200	250	304	693	
250	250	300	310	718	
300	300	350	317	743	
350	350	400	324	768	
400	400	450	330	793	
450	450	500	337	818	
500	500	550	344	843	
550	550	600	350	868	
600	600	650	357	893	

Offset DWECO 45° + Length 500					
	A	B	C	D	
130	130	180	435	609	
150	150	200	440	623	
180	180	230	449	645	
200	200	250	455	659	
250	250	300	470	694	
300	300	350	484	729	
350	350	400	499	765	
400	400	450	514	800	
450	450	500	528	835	
500	500	550	543	871	
550	550	600	558	906	
600	600	650	572	942	

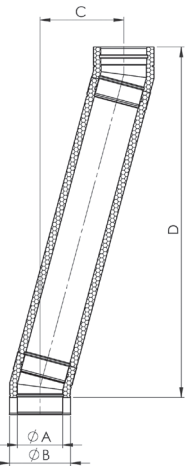

Offset DWECO 15° + Length 1000					
	A	B	C	D	
130	130	180	275	1151	
150	150	200	276	1156	
180	180	230	277	1164	
200	200	250	278	1169	
250	250	300	279	1182	
300	300	350	281	1195	
350	350	400	283	1208	
400	400	450	285	1221	
450	450	500	286	1234	
500	500	550	288	1247	
550	550	600	290	1260	
600	600	650	291	1273	

Offset DWECO 30° + Length 1000					
	A	B	C	D	
130	130	180	544	1091	
150	150	200	547	1101	
180	180	230	551	1116	
200	200	250	554	1126	
250	250	300	560	1151	
300	300	350	567	1176	
350	350	400	574	1201	
400	400	450	580	1226	
450	450	500	587	1251	
500	500	550	594	1276	
550	550	600	600	1301	
600	600	650	607	1326	

Offset DWECO 45° + Length 1000					
	A	B	C	D	
130	130	180	788	963	
150	150	200	794	977	
180	180	230	803	998	
200	200	250	809	1012	
250	250	300	823	1048	
300	300	350	838	1083	
350	350	400	853	1118	
400	400	450	867	1154	
450	450	500	882	1189	
500	500	550	897	1224	
550	550	600	911	1260	
600	600	650	926	1295	

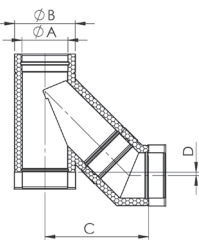

DWECO T45° + Ellbow 45° horizontal					
	A	B	C	D	
130	130	180	389	55	
150	150	200	413	60	
180	180	230	450	66	
200	200	250	474	70	
250	250	300	534	80	
300	300	350	594	91	
350	350	400	655	101	
400	400	450	715	111	
450	450	500	776	122	
500	500	550	836	132	
550	550	600	896	142	
600	600	650	957	153	

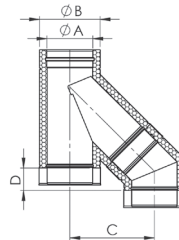

DWECO T45° + Ellbow 45° vertical					
	A	B	C	D	
130	130	180	272	62	
150	150	200	292	62	
180	180	230	322	62	
200	200	250	342	62	
250	250	300	392	62	
300	300	350	442	62	
350	350	400	492	62	
400	400	450	542	62	
450	450	500	592	62	
500	500	550	642	62	
550	550	600	692	62	
600	600	650	742	62	

WEIGHTS

Weights (kg) DW ECO 2.0

Ø	L = 1000	L = 500	L = 250	Te 90°	Te 45°	Elbow 45°
130	5,2	2,5	1,2	2,2	2,9	1,2
150	5,8	2,9	1,4	2,6	3,5	1,4
180	6,8	3,4	1,6	3,2	4,4	1,7
200	7,5	3,7	1,8	3,6	5,1	1,9
250	8,3	4,1	2,0	4,8	7,1	2,2
300	10,8	5,3	2,6	6,2	9,3	3,2
350	12,5	6,2	3,0	7,7	11,8	3,9
400	14,1	7,0	3,4	9,3	14,7	4,8
450	15,8	7,8	3,8	11,1	17,9	5,7
500	17,5	8,6	4,2	13,1	21,2	6,6
550	19,1	9,4	4,6	15,2	24,9	7,6
600	20,8	10,3	5,0	17,4	28,9	8,7

Wall Thickness 0,5 mm and standard 25 mm insulation thickness – please contact Jeremias technical department for weight details on other thickness.



INSTALLATION HEIGHTS

Installing Heights in metres

Ø	A	B	C	D
	distance between wall supports	distance between wall brackets	Freestanding height above last support	installing height from T branch
Ø	wall supports: 05, 06, 07 in combination with cantilevers 391/392/393	adjustable wall bracket 690	adjustable wall bracket 690	in combination with adjustable support 03 / base support 66
130	50	4	3	30
150	40	4	3	25
180	35	4	3	20
200	35	4	3	15
250	30	4	3	15
300	25	4	3	15
350	25	4	2,5	10
400	20	4	2,5	10
450	20	4	2,5	10
500	15	4	2,5	10
550	10	4	1,5	5
600	10	4	1,5	5

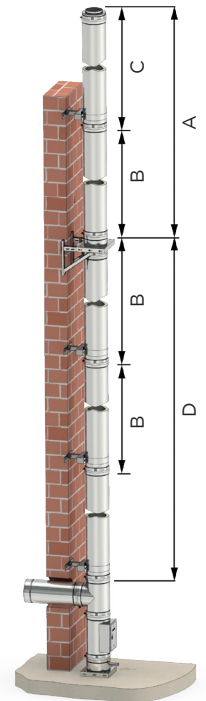
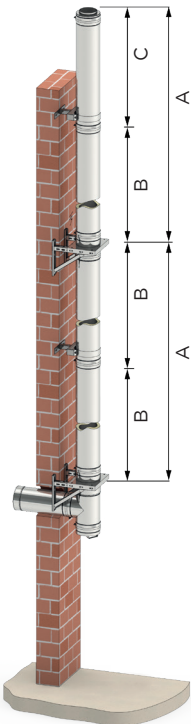

Please take these distances as general reference. Please contact our technical department for exact documentation on weights and installation heights.

ONE SYSTEM MULTIPLE APPLICATIONS

The **Jeremias group** of companies has been present in the flue industry for **more than 40 years**, and now is the **stainless steel flue systems manufacturer** with the largest number of **CE certified systems**. The CE MARK is the symbol - obligatory since April 2005 - that certifies that a stainless steel chimney is in accordance with the EN 1856-1.

This standard specifies the performance requirements for rigid single and multi-wall system chimney products with metallic liners (chimney sections, chimneys fittings and terminals, including supports) used to convey the products of combustion from appliances to the outside atmosphere.

It also specifies the requirements for marking, manufacturer's instructions, product information and evaluation of conformity of the product to the standard. The EN 1856-1 introduces a requirement for a certified factory production control system, which is in addition to any existing ISO 9000 factory quality scheme. This ensures, through continuous assessment and external quality audits, that the manufactured product conforms with the performance designation of the product.

A simple code will give the user information about the suitability of the system for different applications.

CE Designation: EN 1856-1 T600 N1 V3-L50040 G70

TEMPERATURE CLASS

T80, 100, 120, 140, 160, 200, 250, 300, 400, 450, 600

This indicates the normal maximum operating temperature of the chimney.

PRESSURE CLASS

N1, N2, P1, P2, H1, H2

The pressure class relates to the product's suitability and gas tightness when used on positive pressure applications up to 200 pa (P), negative (N) draught applications, and high positive pressure (H) applications and is further classified as to the degree of leakage allowed with either a 1 or 2, with 1 having the lowest leakage rate.

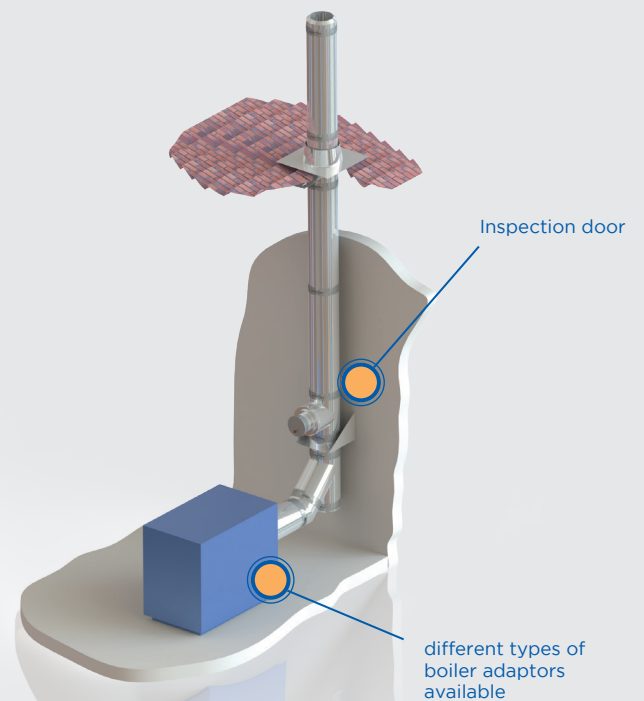

Standard floor standing Boiler:

DW ECO 2.0 is the solution for small commercial and industrial standard natural draft or pressure jet boilers.

DW ECO 2.0 is suitable for wet conditions, with a capillary break in every joint. Depending the kind of fuel and sulphure content alternative inner wall stainless steel alloys are available under request. Please consult first your national installation guidances and regulations before ordering.

CE Designation: T400 N1 V2-L50040 O30

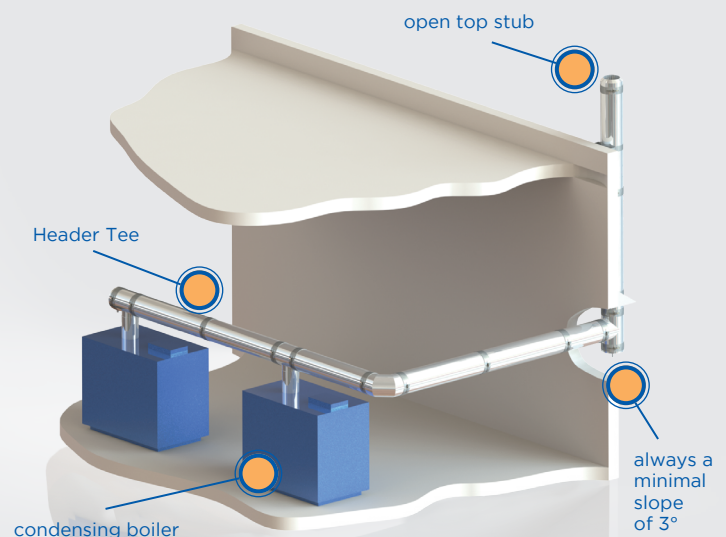

Condensing boilers in cascade:

DW ECO 2.0 can be installed to fit modern condensing appliances in cascade. using high quality silicone joints in every component **DW ECO 2.0** can hold positive pressure till 200 pa. a slope of 3° minimum is compulsory in horizontal runs, therefore the use of Tees and elbows in 87° is needed.

The use of drain points in the most critical parts of the installation is recommended the special designed header tees are necessary when connecting multiple appliances into a common Header, these are fully welded and guarantee the water resistance of the installation. Please read our technical manual and installing instructions or contact our technical department for installing advise.

CE Designation: T200 P1 W V2-L50040 O00

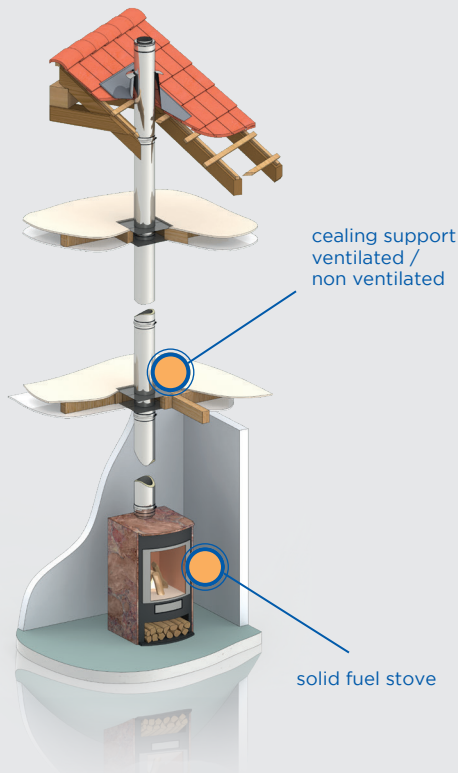

Stoves and Fireplaces:

DW ECO 2.0 is an ideal solution for the installation of stoves and fireplaces. high quality at an economic price. Jeremias has developed market specific components and supports adapted to all kind of installation rules. DW ECO 2.0 is an HETAS listed product and 4 hour fire rated to BS 476 part 20.

Please respect local regulations regarding minimum distances to combustible materials, Jeremias can supply technical guidance on various standards and country specific installing regulations

CE Designation: T450 N1 V3-L50040 G60

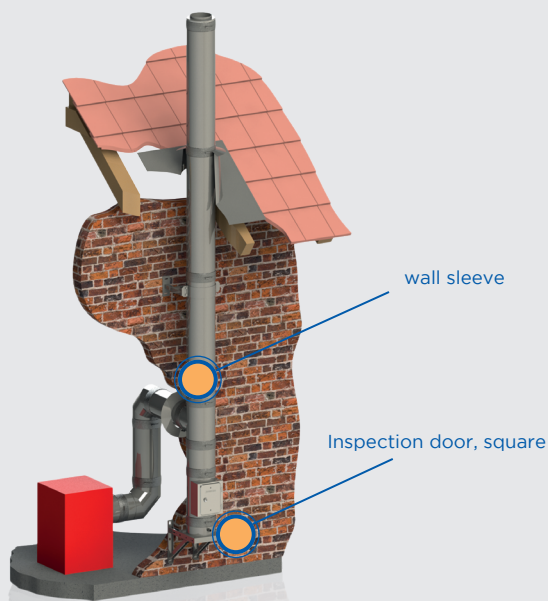

Biomass Boiler:

A typical application for the chimney system DW ECO 2.0 are biomass boilers. heating with biomass a CO₂ neutral alternative for individual houses, apartments or office buildings DW ECO 2.0 gives the solution for the smoke exhaust. DW ECO 2.0 is tested to 600° C continuous operating temperature and soot fire tested at 1000° C and has the highest corrosion resistance level V3.

Please note that frequent cleaning and maintenance of the chimney system (specially with solid fuel) will extend the lifetime of the product. Jeremias provides a 10 year warranty.

CE Designation: T600 N1 V3-L50040 G70

CONDENSATE RESISTANCE CLASS

W=Wet, D=Dry

CORROSION RESISTANCE

V1, V2, V3, Vm

V1: Sulphur content $\leq 50 \text{ mg/m}^3$, natural gas L+H Kerosene: Sulphur content $\leq 50 \text{ mg/m}^3$.

V2: Natural gas L+H Oil: Sulphur content $\leq 0.2 \text{ mass } \%$ Kerosene: Sulphur content $\geq 50 \text{ mg/m}^3$ Wood in open fireplaces.

V3: Natural gas L+H Oil: Sulphur content $> 0.2 \text{ mass } \%$ Kerosene: Sulphur content $\geq 50 \text{ mg/m}^3$ Wood in open fireplaces. Wood in closed stoves, Coal Peat

Vm: Self declared by the manufacturer as suitable for the application based on product history and historical performance in the field. The corrosion resistance class should be matched against the fuel type.

THE LINER SPECIFICATION

The liner specifications offer a number of material codes together with the lowest diameter liner thickness.

SOOT FIRE RESISTANCE

G [X] = with soot fire resistance

O [X] = without soot fire resistance

[X] = product declared minimum distance to combustible material in mm.

The CE Mark enables the product to circulate freely in the European market, being the highest standard for metal chimney systems in the world; nevertheless each country could have its own installation rules. Jeremias also has a wide range of specific certifications to enforce national, regional or even local regulations. No matter where the project will be installed Jeremias will provide the necessary certification to meet the local approvals procedure.

For any specific documentation needed during project specification please contact our technical department.

PRODUCTION SITES

GERMANY

Jeremias GmbH
Opfenrieder Str. 11-14
91717 Wassertrüdingen
phone: +49 (0) 9832 6868-50
e-mail: info@jeremias.de
www.jeremias.de

POLAND

www.jeremias.pl

SPAIN

www.jeremias.com.es

RUSSIA

www.jeremias.ru

USA

www.jeremiasinc.com

CZECH REPUBLIC

www.jeremias.cz

UNITED KINGDOM

www.jeremias.uk

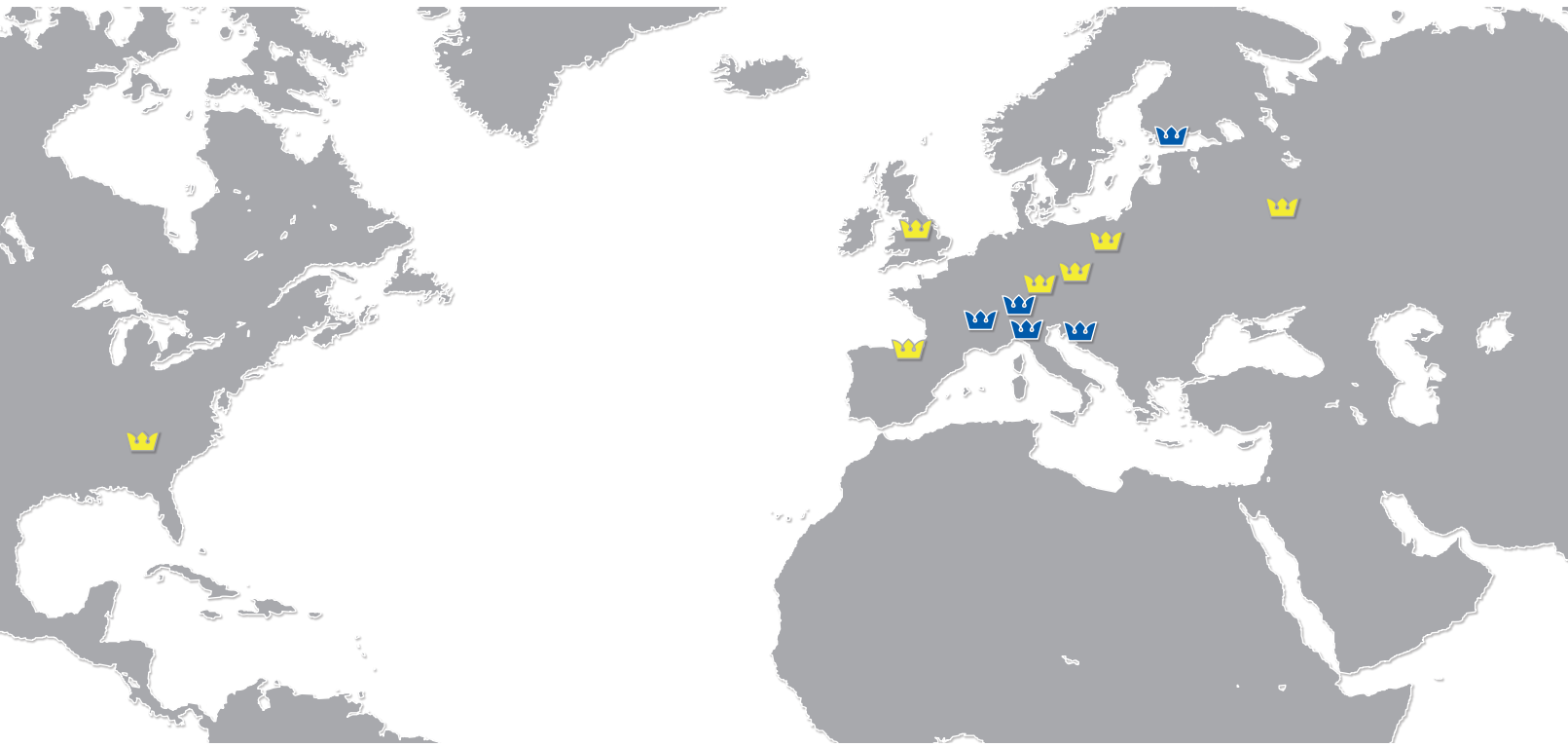

SALES OFFICES

FRANCE

www.jeremias-france.fr

CROATIA

www.jeremias.hr

FINLAND

www.jeremias.fi

SWITZERLAND

www.jeremias-schweiz.ch

ITALY

www.jeremias.it

JEREMIAS IS REPRESENTED IN THE FOLLOWING COUNTRIES:

Austria | Belarus | Belgium | Bulgaria | Brazil | Denmark | Estonia | Hong Kong | Ireland | Kazakhstan | Latvia | Lithuania | Luxembourg | Malta | Netherlands | Norway | Portugal | Romania | Saudi Arabia | Serbia | Singapore | Slovakia | Slovenia | South Africa | Sweden | Tunisia | UAE | Ukraine

The expert in your area:

Jeremias high quality products to be installed only by selected experts.